

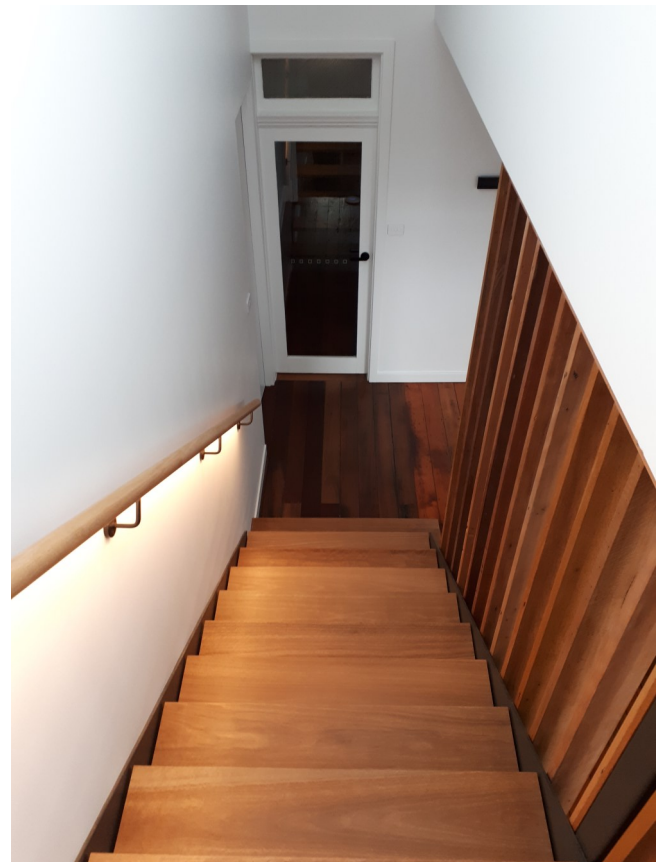

- Select grade American Oak timber
- Diameter 43mm with 15x15 rebate
- Timber lengths up to 5.3m
- LED Profile insert Lightrail 1414
- LED strip options—see specifications
- Albion brackets matt black, matt white
- Albion brackets satin brass , satin stainless
- Chifley brackets satin stainless , matt black
- Componentry supply in kit or separately
- Final cutting and assembly on site
- Uniform dot free illumination





+

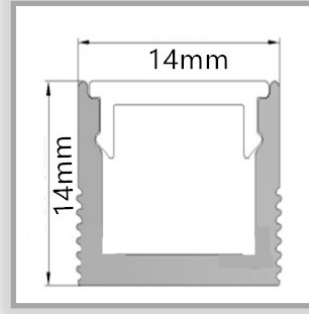

+



**TIMBER + 1414 LED PROFILE INSERT + LED STRIP**





## LIGHTRAIL ALBION & CHIFLEY BRACKETS

The Lightrail Albion & Chifley brackets are supplied in solid and hollow versions ( for power entry). Both types are supplied with the specially designed 1414MB hollow fixing block.

This unique addition to the bracket enables LED strip to remain continuous and avoids unnecessary joins to complete a linear, dot free and clean illumination without interruption.

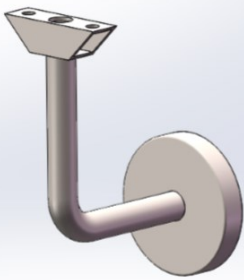

**ALBION**

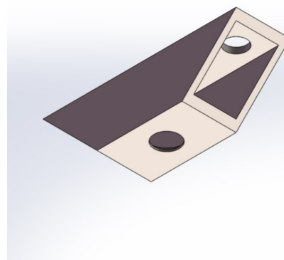

**1414MB**

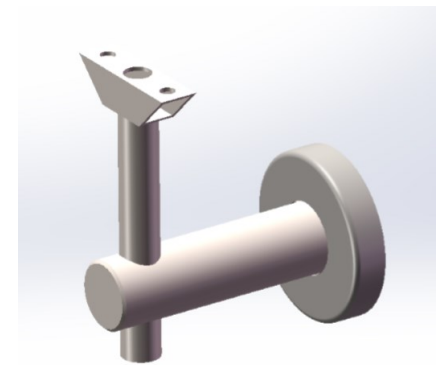

**CHIFLEY**

**LED STRIP PASSES THROUGH**



**DIFFUSER SLIDES OVER**

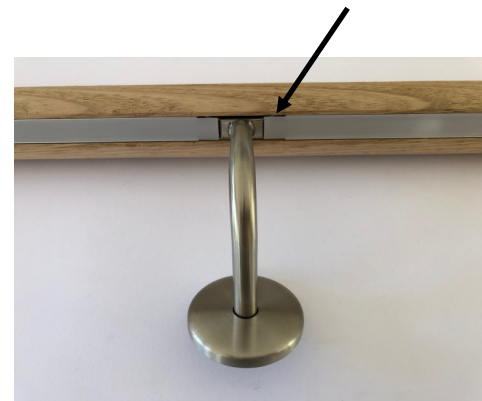

## LIGHTRAIL ALBION BRACKETS



**MATT BLACK**

**MATT WHITE**

**SATIN BRASS**

**SATIN STAINLESS**



LIGHTRAIL CHIFLEY BRACKETS—316 SATIN STAINLESS + MATT BLACK

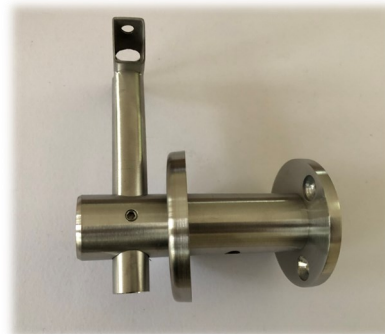
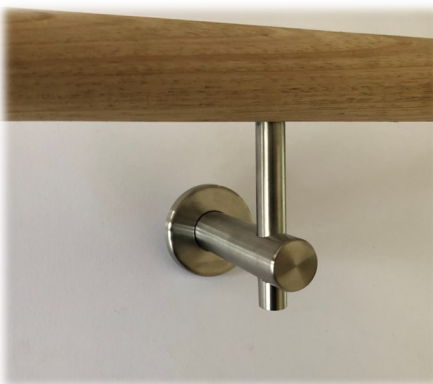
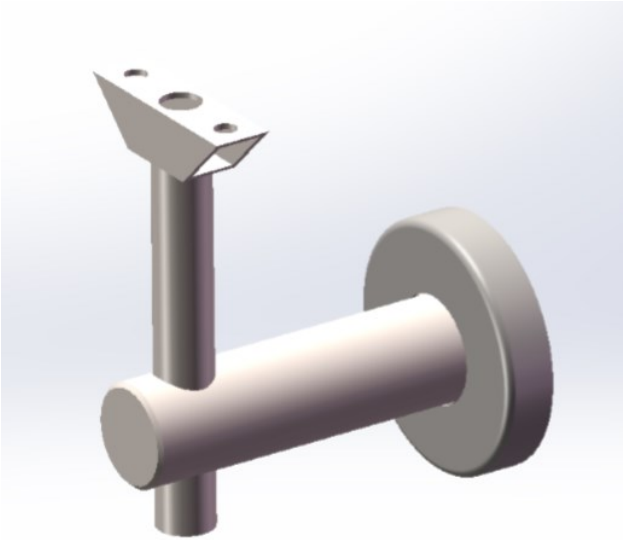

**LIGHTRAIL VICTORIAN ASH ACCESSORIES**

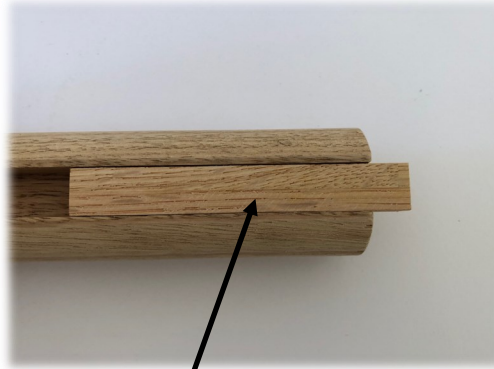

**INFIL 100mm or per m**

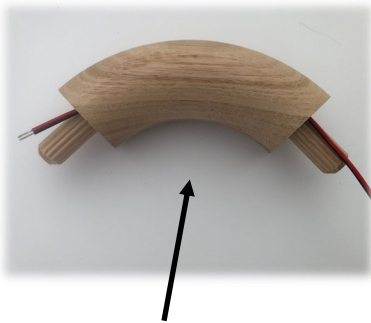

**Cable allowance in bend**



**90deg elbow**

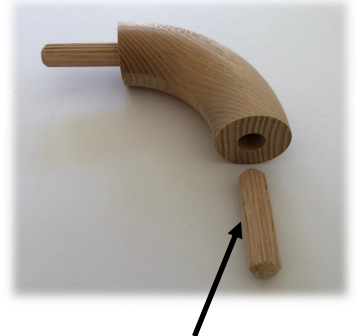

**16mm dowel**



**Domed end cap**





## BLACKLINE SERIES

The Lightrail Blackline series is a commercial grade LED strip that produces up to 130 lumens per watt and also enables long length of up to 20m powered at just one end. The efficiency of this series enables your required light levels to be achieved by using up to 20% less power . For example: BL68 6.8w can match 9.6w, BL11 11w can match 14.4w and 15w will achieve a staggering 1900lm which is usually only available with some 19.2w strips. In addition to this , the high quality Samsung LED chip is only powered at around 55mA which is one third of its load capacity of 150mA. This creates maximum stability and peace of mind for your project



## BLACKLINE SERIES



CODE	V	W	LED/m	COL TEMP	Approx LUMEN/M	MAX LENGTH
BL68.27K	24	6.8	120	2700K	732	20m
BL68.3K	24	6.8	120	3000K	744	20m
BL68.4K	24	6.8	120	4000K	806	20m
BL68.6K	24	6.8	120	6000K	806	20m

CODE	V	W	LED/m	COL TEMP	Approx LUMEN/M	MAX LENGTH
BL11.27K	24	11	120	2700K	1298	15m
BL11.3K	24	11	120	3000K	1320	15m
BL11.4K	24	11	120	4000K	1430	15m
BL11.6K	24	11	120	6000K	1430	15m

CODE	V	W	LED/m	COL TEMP	Approx LUMEN/M	MAX LENGTH
BL15.27K	24	15	120	2700K	1770	15m
BL15.3K	24	15	120	3000K	1800	15m
BL15.4K	24	15	120	4000K	1950	15m
BL15.6K	24	15	120	6000K	1950	15m



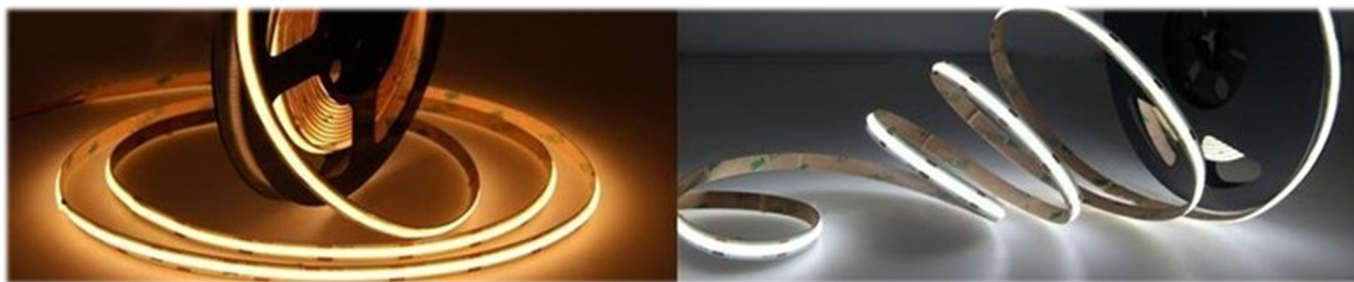

## COB ECONOMY LED

The Lightrail COB series is a reliable domestic grade LED strip and with an astonishing 480 LED's per metre. This strip can achieve a dot free illumination within a very shallow profile making it an excellent choice for your domestic LED handrail or LED joinery installation at a very affordable price with trusted Lightrail reliability.

The ultra thin clear quick connectors enable versatility and on site last minute adjustments if required

CODE	V	W	LED/m	COL TEMP	Approx LUMEN/M	MAX LENGTH
COB480.96.27K	24	9.6	480	2700K	720	15m
COB480.96.3K	24	9.6	480	3000K	768	15m
COB480.96.4K	24	9.6	480	4000K	816	15m
COB480.96.3K	24	9.6	480	3000K	864	15m

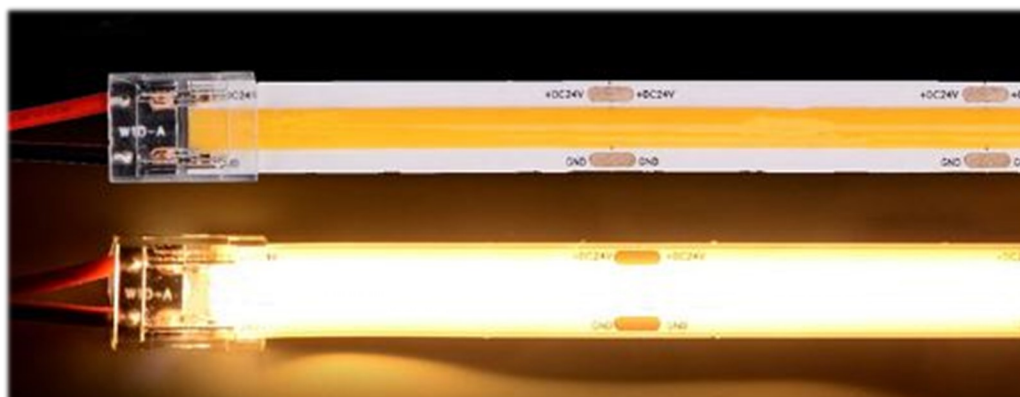

## ACCESSORIES

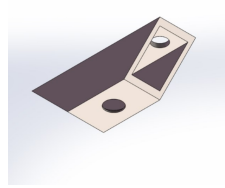

CODE	DESCRIPTION
THVA43-EC	DOMED END CAP 43mm VIC ASH
THVA43.INF100	INFIL VIC ASH 100mm SUIT LIGHTRAIL SYSTEMS
SS-GACA	GLASS ADAPTOR SUIT LIGHTRAIL BRACKETS
MB1414	MOUNTING BLOCK ONLY SUIT LIGHTRAIL BRACKETS
THVA43-E90C	ELBOW 90DEG WITH JOINING DOWEL AND CABLE ALLOWANCE

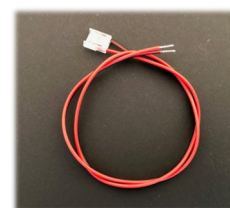
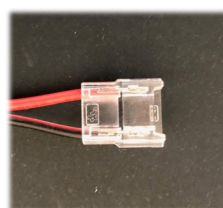
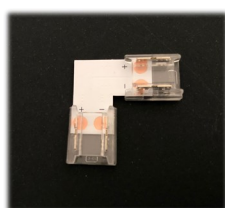

CODE	DESCRIPTION
CON-L90	LED STRIP 10mm PCB 90DEG CONNECTOR
CON-SJ	LED STRIP 10mm PCB STRAIGHT JOINER
CON-500	LED STRIP 10mm PCB CONNECTOR WITH 500mm LEAD

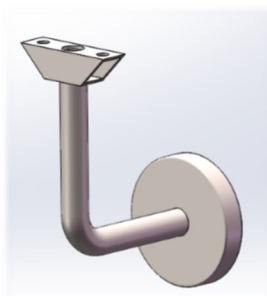

CODE		FINISH	
SSABS	ALBION BRACKET 316 STAINLESS STEEL	SOLID	SATIN STAINLESS
SSABS-MB	ALBION BRACKET 316 STAINLESS STEEL	SOLID	MATT BLACK
SSABS-MW	ALBION BRACKET 316 STAINLESS STEEL	SOLID	MATT WHITE
SSABS-SB	ALBION BRACKET 316 STAINLESS STEEL	SOLID	SATIN BRASS

CODE		FINISH	
SSABH	ALBION BRACKET 316 STAINLESS STEEL	HOLLOW	SATIN STAINLESS
SSABH-MB	ALBION BRACKET 316 STAINLESS STEEL	HOLLOW	MATT BLACK
SSABH-MW	ALBION BRACKET 316 STAINLESS STEEL	HOLLOW	MATT WHITE
SSABH-SB	ALBION BRACKET 316 STAINLESS STEEL	HOLLOW	SATIN BRASS

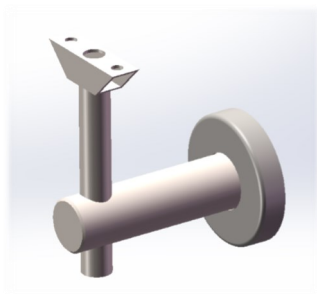

CODE		FINISH	
SSCBS	CHIFLEY BRACKET 316 STAINLESS STEEL	SOLID	SATIN STAINLESS
SSCBS-MB	ALBION BRACKET 316 STAINLESS STEEL	SOLID	MATT BLACK

CODE		FINISH	
SSCBH	CHIFLEY BRACKET 316 STAINLESS STEEL	HOLLOW	SATIN STAINLESS
SSCBH-MB	ALBION BRACKET 316 STAINLESS STEEL	HOLLOW	MATT BLACK

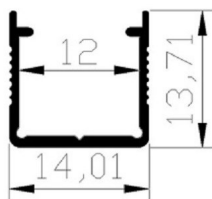
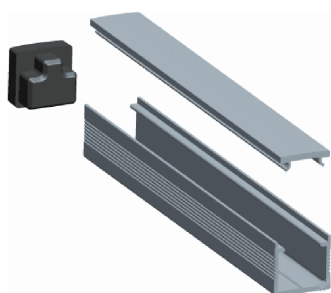

CODE	
1414OPP25	1414 LED PROFILE INSERT WITH OPAL PC DIFFUSER 2500mm
1414ECC/O	END CAP CLOSED / OPEN SUIT LIGHTRAIL 1414 PROFILE INSERT