

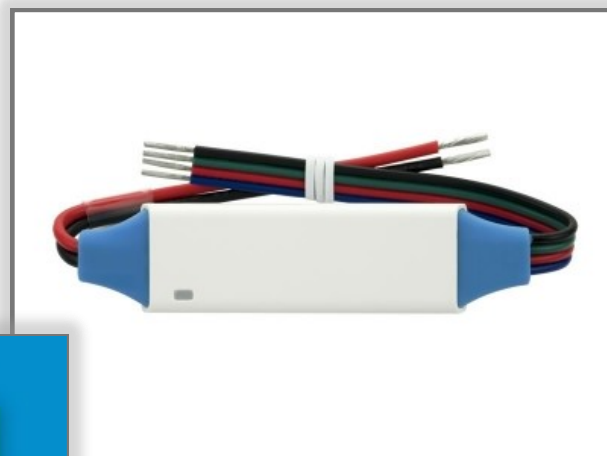

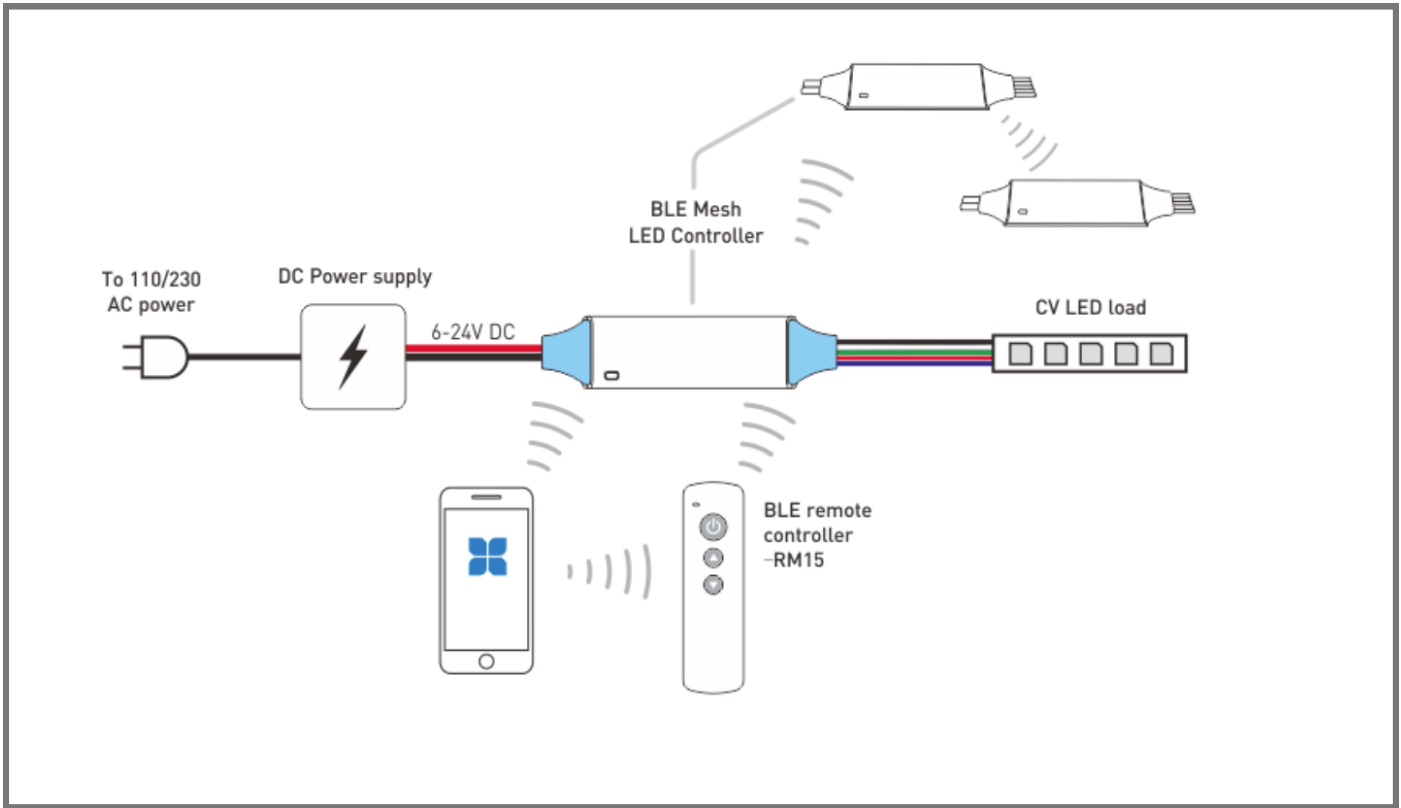







- RADAR M30 LED RGB controller
- Constant Voltage: DC6-24V
- Output Current: 3*5A
- Smart Phone/Bluetooth connection, download free 'Light Mesh' app.
- Synchronized and operated by smart phone with group features
- Wireless Distance: >15m
- Working Temperature: -30/60°C
- IP68





 Smartphone Control	 Full Protection	 Waterproof Optional	 High Power
 Mesh Connection	 Scene Program	 Wide Voltage Range	 Compact Size

